

Showers



ZDOCNF00398

Hand Shower

FEATURES

Elegant design

ABS hand-shower (Four spray-functions)

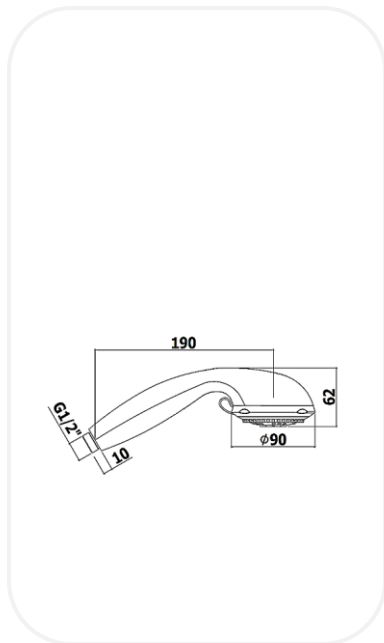

SPECIFICATIONS

Series RAIN

Finish Chrome

Material ABS

Dimension Ø 90 mm

PARTS DESCRIPTION

Hand Shower

ZDOCNF00398

WARRANTY: 5 years