

Showers



ZSOFNF00302

Shower Head

FEATURES

Elegant design

Anti-scale System
Thickness 6.5mm

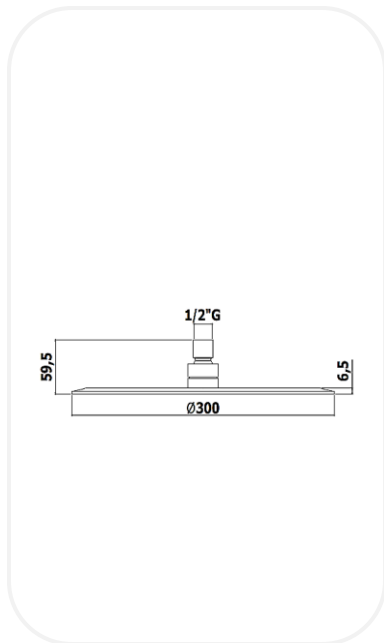

SPECIFICATIONS

Series	WATERFALL
Finish	Chrome
Material	Metal
Dimension	Ø300mm
Shape	Round

PARTS DESCRIPTION

Shower Head	ZSOFNF00302
--------------------	-------------

WARRANTY: 5 years